

План в осях 1/2 - А/В
 ГН 008 - 3,0х3,0 - 44х130

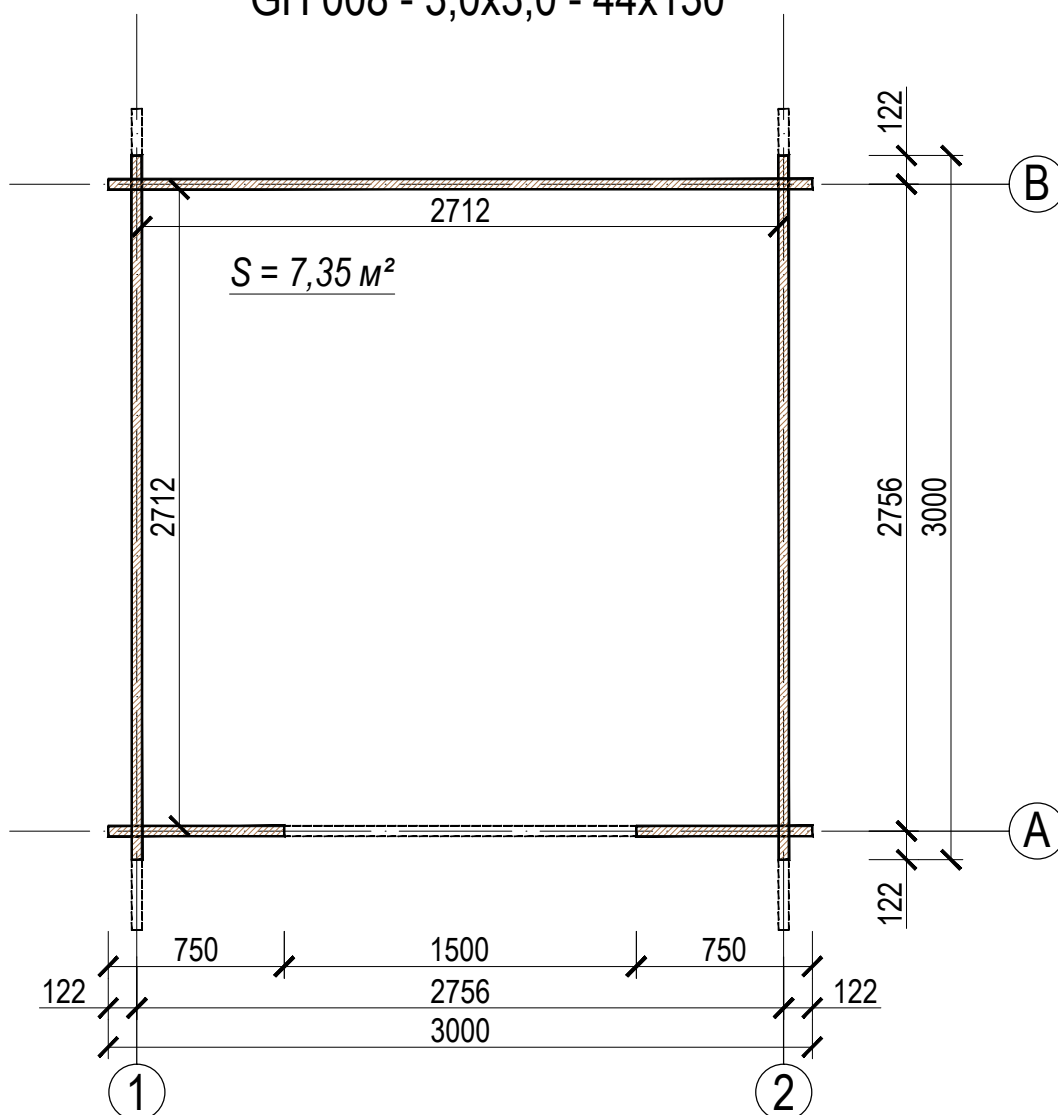

Стена по оси В

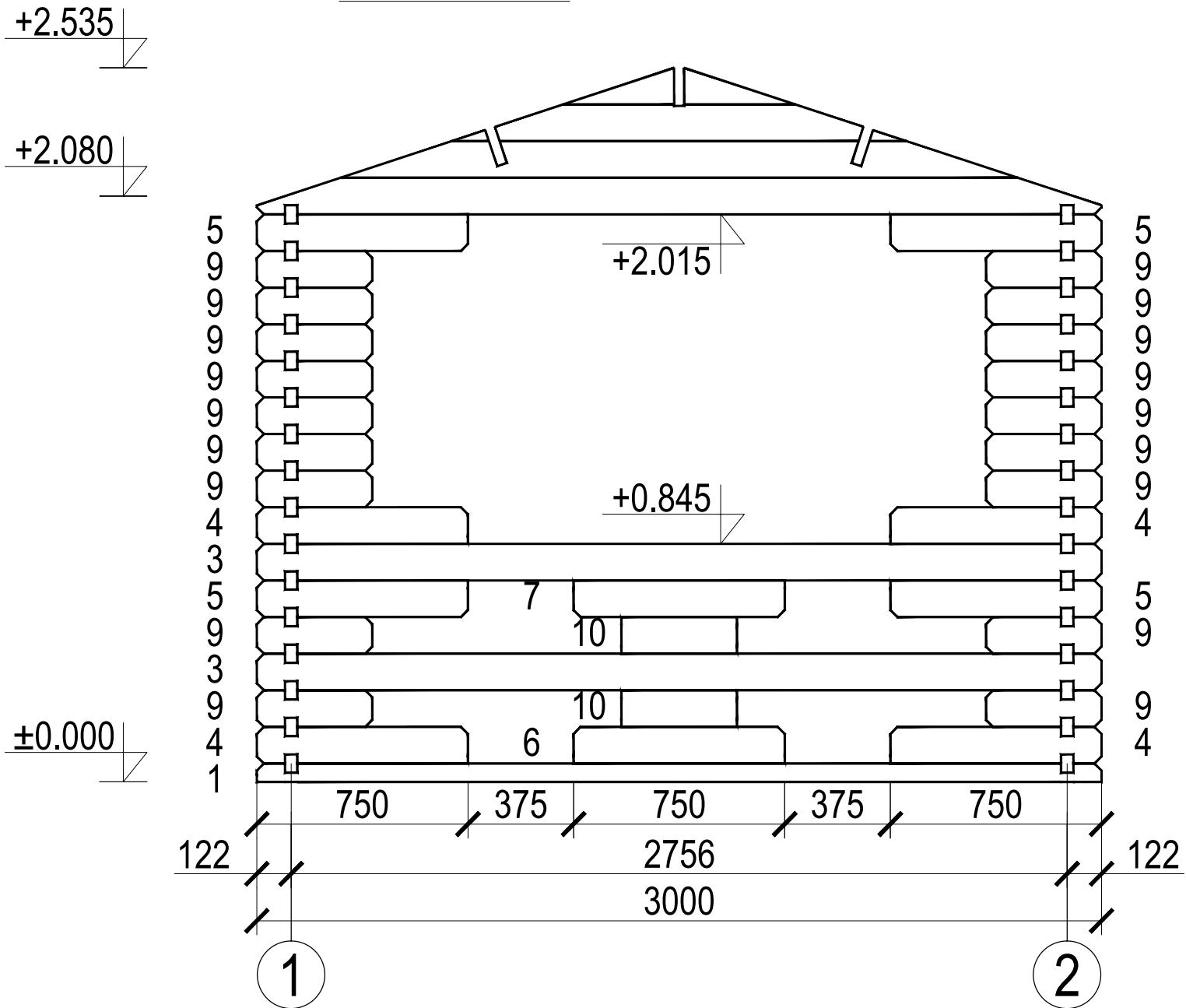

Стена по оси А

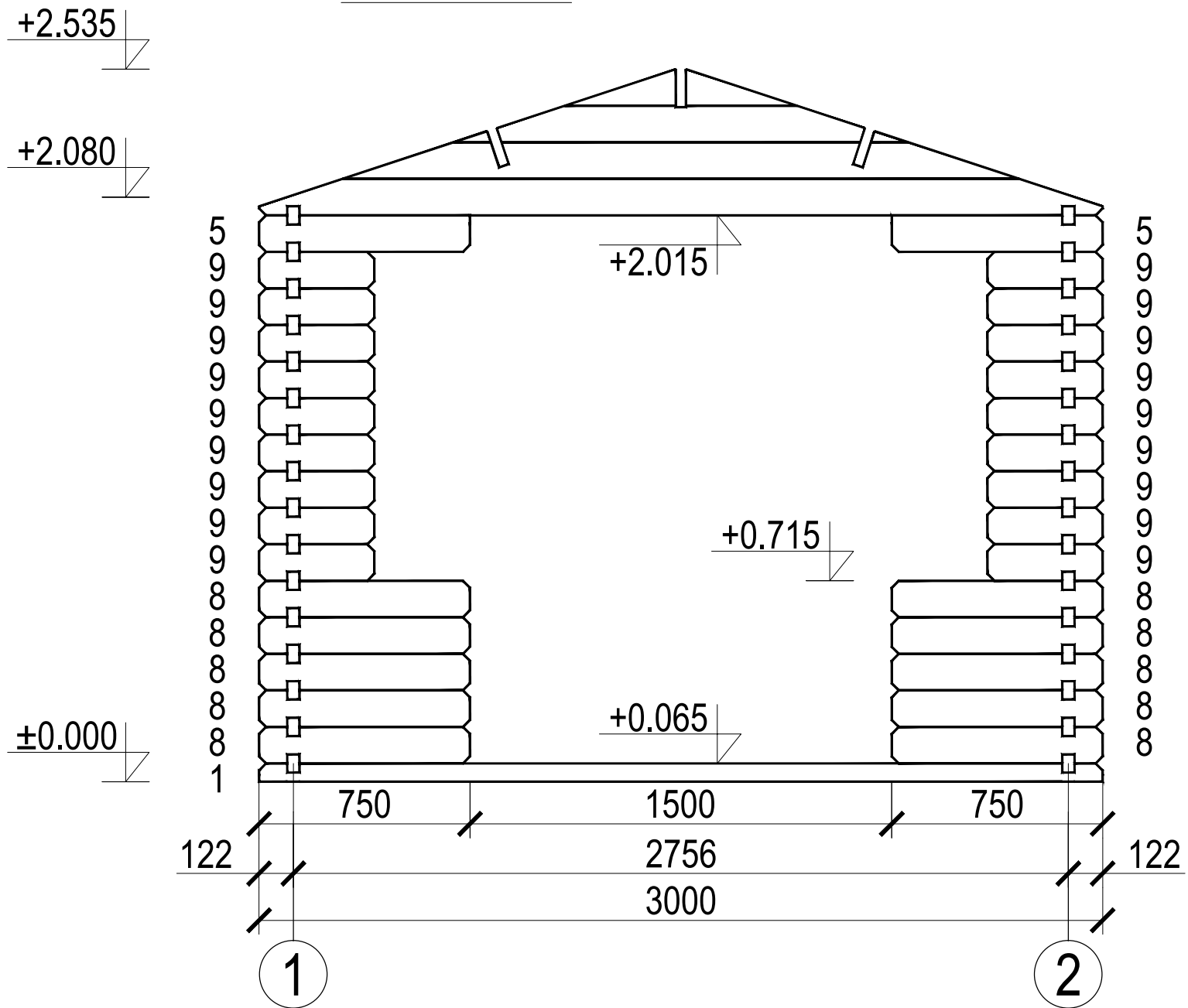

Стена по оси 1

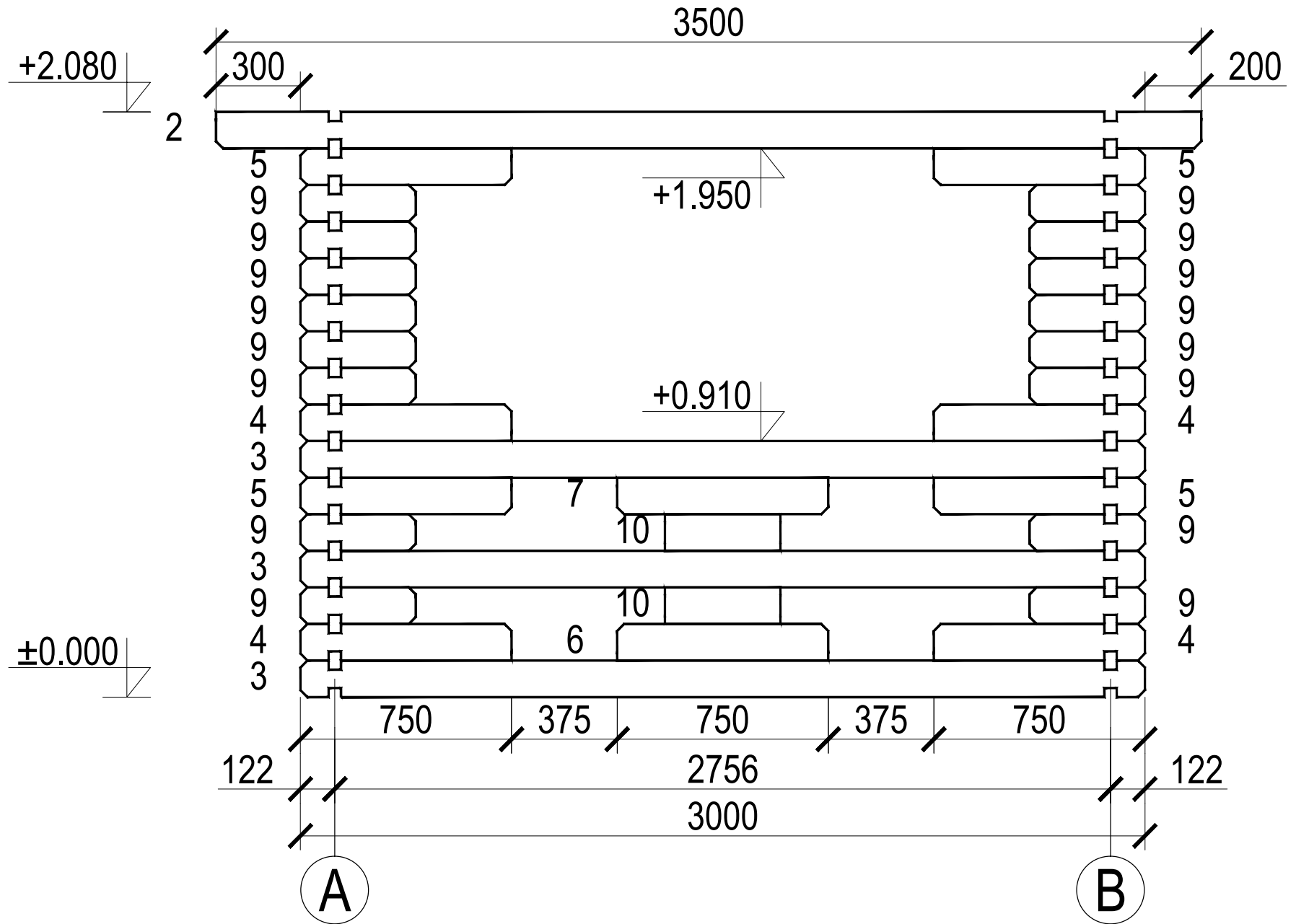

Стена по оси 2

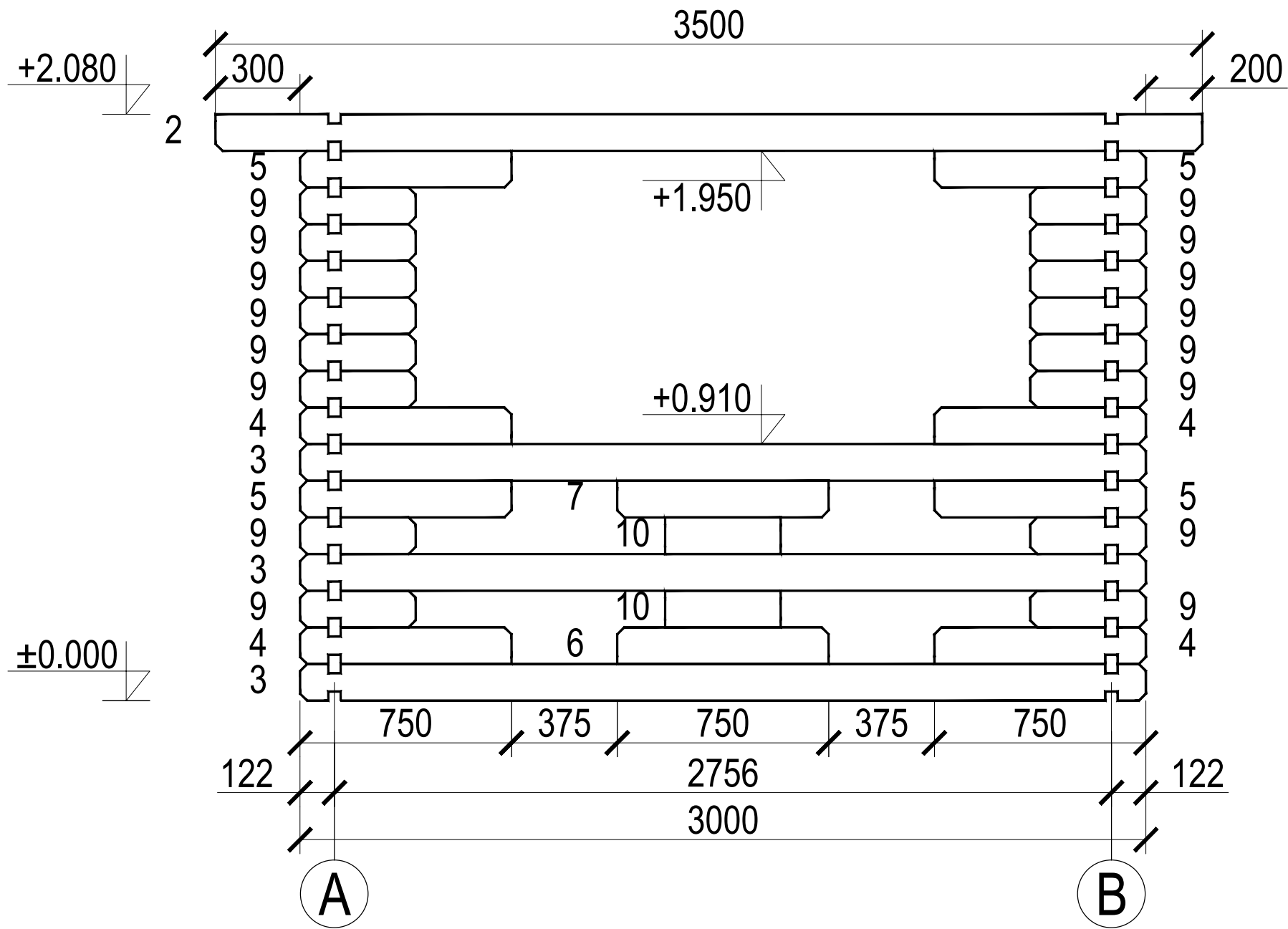

Фронтон по оси А, В

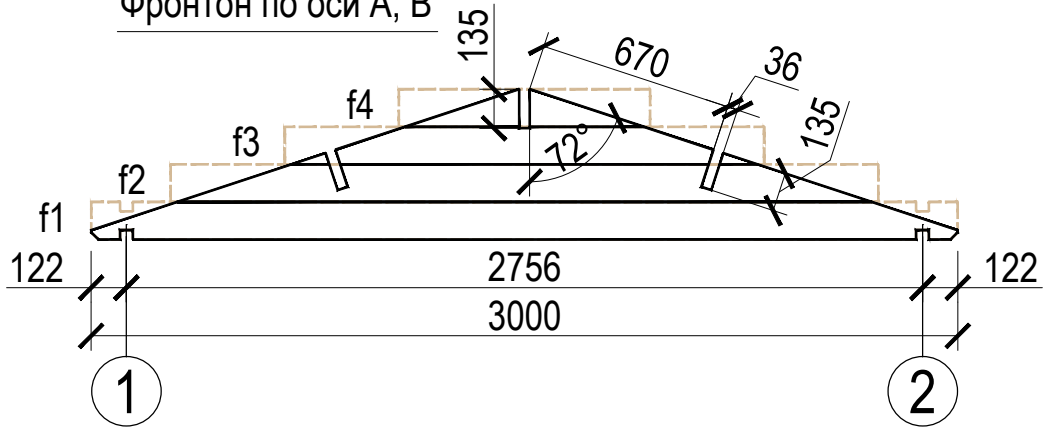

Стропила 44x135

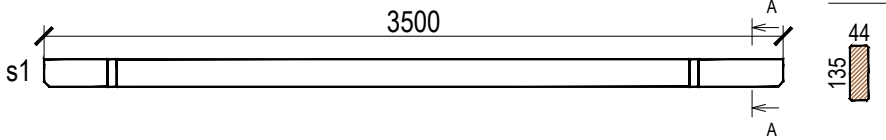

Стартовая деталь

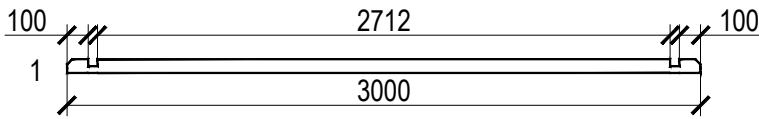

Передняя ветрозащитная планка

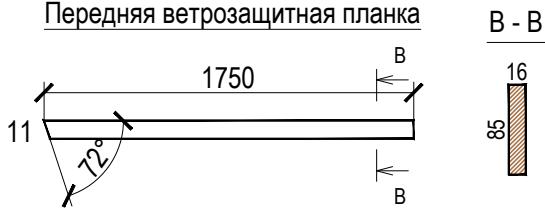

Верхняя ветрозащитная планка

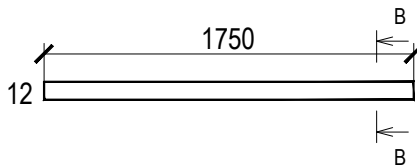

Боковая ветрозащитная планка

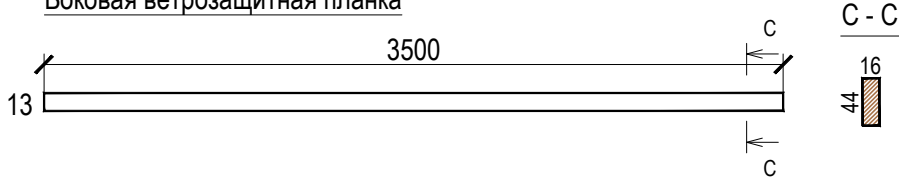

Нащельник ромб



Перила

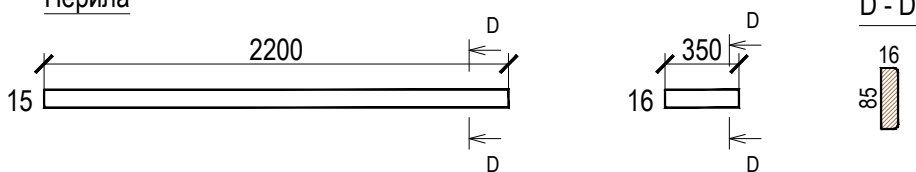

Планка

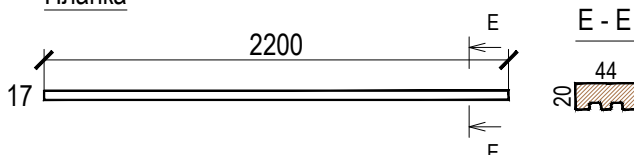

№	Рисунок детали	Длина	Шт.			
Стартовая деталь						
1		3000	2			
Стены						
2		3500	2			
3		3000	8			
4		750	12			
5		750	14			
6		750	3			
7		750	3			
8		750	10			
9		410	68			
10		410	6			
Фронтон						
f1		3000	2			
f2		2450	2			
f3		1660	2			
f4		870	2			
Стропила брус 44x135						
s1		3500	3			
№	Наименование детали	Длина	Количество			
11	Передняя ВЗП 16x135	1750	4			
12	Верхняя ВЗП 16x135	1750	4			
13	Боковая ВЗП 16x55	3500	2			
14	Нащельник ромб	шт.	2			
15	Перила 16x85	2200	3			
16	Перила 16x85	350	2			
17	Планка 44x20	1500	1			
18	Плинтус	пог.м.	18			
19	Лаги 50x70	2700	6			
20	Пол	2700	28x85	28x90	28x113	28x130
			32	31	24	21
21	Вагонка на крышу	1700	16x85	16x90	16x113	16x130
			42	39	31	27
22	Вагонка на крышу	1700	16x85	16x90	16x113	16x130
			42	39	31	27

